

65101-11782-J

Read the instruction before operating your shade

Installation & Maintenance Instructions Honeycomb Shade Corded / Corded TDBU / Corded Day & Night

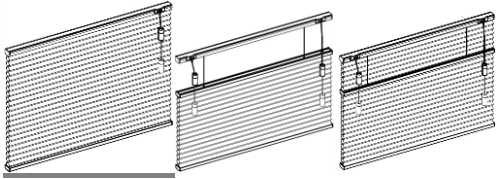

Getting Started

Remove the shade from the package. Save the packaging until the shade is installed and working to your satisfaction.

Tools Needed :

- Power drill and drill bit
- Measuring tape
- Screwdriver
- Level
- Pencil



You will need to use the following fasteners for your particular mounting surface.

Surface	Fastener
Wood	Screw (Provide)
Drywall/Plaster	Wall Anchors, Expansion Bolts (Not Provide)
Metal	Sheet Metal Screws (Not Provide)

Check Component/Hardware:

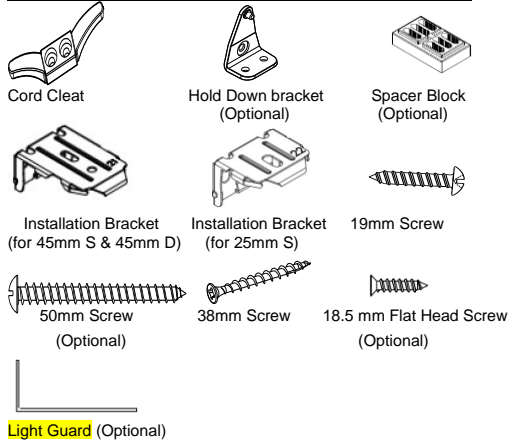

Step 1: Bracket Installation

Measure 75mm from both ends of the head rail. Mark the bracket location on the mounting surface. Proper alignment of brackets will make installation easier.

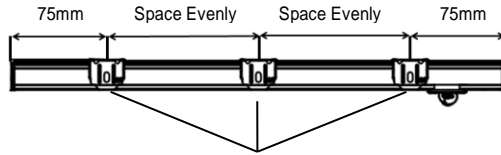

Installation Bracket

a. for 25mm Single cell Inside Mount:

Allocate a min. distance of 8mm from the edge of the wall to the front of brackets. Use one 38mm screws to secure brackets.

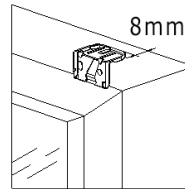

Outside Mount:

Allocate a minimum distance of 7mm from the end of brackets to the top window frame. Use one 38mm mounting screws to attach each bracket.

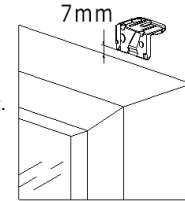

b. for 45mm S & 45mm D Inside Mount:

For 45mm S & 45mm D, allocate a minimum distance (L1) from wall to the front of brackets

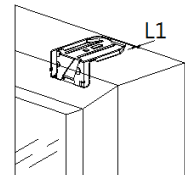

Distance	Application Condition
$L1 \geq 4mm$	With light guard front and back
$L1 \geq 0mm$	Without light guard, & with light guard at back

Outside Mount:

Allocate a min. distance of 6mm from the end of brackets to the top window frame. Use two 38mm screws to secure brackets. Use wall anchors for drywall or plaster wall.

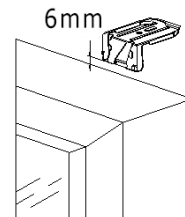

Note: If spacer block is required for outside mount, please follow the following guide:

	25mm Single	45mmS & 45mm D
Please always make sure the raised side of the spacer block is against the bracket.		
If 2pcs spacer blocks are required, please follow the right illustration to attach the spacer blocks.		

Mount the combination of the bracket and spacer block with 38mm screws for 1 set spacer block, use 50mm screws for 2 sets spacer blocks.

The window frame protrudes from wall by 0~10mm, one spacer block is used.	
The window frame protrudes from wall 10~18mm, two spacer blocks are used.	

Step 2: Shade Installation

Corded / Corded Day & Night:

a. Position the shade so that the front is facing you.

b. Insert the rail with an angle facing the window; hooking up with the bracket front side, and then push it upward to snap into the bracket. For proper installation, start with attaching the front rail to the bracket.

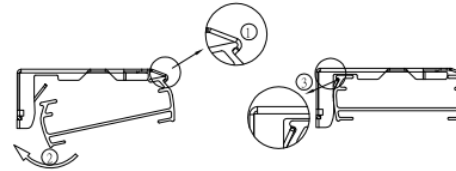

Corded TDBU:

a. To lower the middle rail by lowering the bottom rail first.

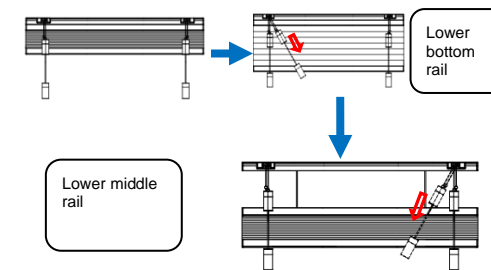

b. Position the shade so that the front is facing you. Insert the rail with an angle facing the window, hooking up with the bracket front side, and then push it upward to snap into the bracket. For proper installation, start with attaching the front rail to the bracket.

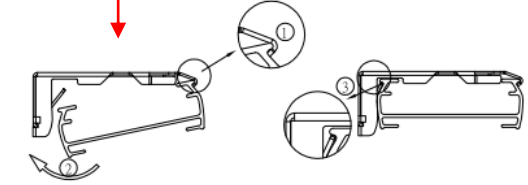

Step 3: Install Light Guard (Optional for IM)

Please install the light guard after installation of the shade is completed.

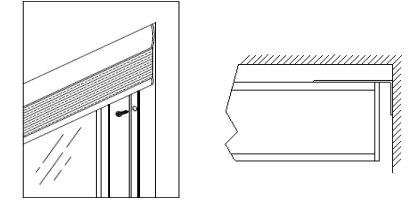

With light guard at back

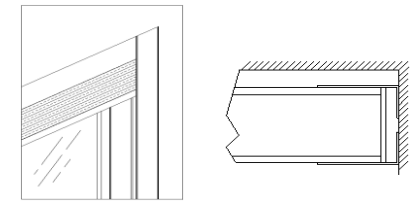

With light guard at front and back

a. The light guard is to be placed at back or front of the shade at left & right side.

Place the light guard vertically towards the bottom window frame. To avoid scraping, leave a 2mm gap between fabric stack and light guard. And then mark out the location with a pencil.

Remove the double sided tapes on the narrow side of the light guard and carefully paste the light guard to the window frame in position.

b. For better fixing the **light guard** to the window, use 18.5mm flat head screw to secure the light guard through the pre-drilled hole.



c. When light guard length (L) > 2438mm, light guard will be sliced into 2 pieces. There are two conditions as listed below.

Light guard length (L)	Short piece Light Guard Length	Long piece Light Guard Length
2438mm $\leq L \leq 3048\text{mm}$	610mm	L-610mm
L > 3048mm	L-2438mm	2438mm

When light guard sliced into 2pcs, firstly paste the longer piece of light guard vertically towards the bottom window frame, and paste the shorter piece of light guard above the longer one, the edges must be carefully aligned.

To avoid the edges from scraping the fabric, use the protective sticker to completely cover the joint of the two pieces of light guard on both front and back sides of light guard as diagram on the right.

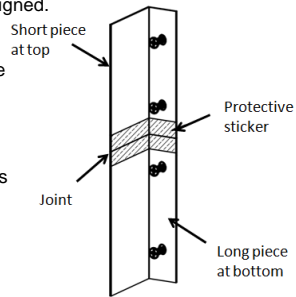

Step 4: How to Install Hold Down (if applicable)

A. For Hold Down Bracket.

• Use 19mm screw to secure each bracket.

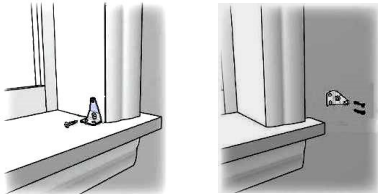

B. For Magnetic Hold Down

Use M3x15mm screw to secure the magnet catch at the below location. Make sure the magnet catch align with the pre-installed magnet on shade bottom rail.

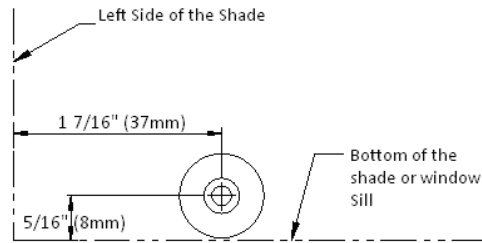

Step 5: Shade Operation

For Corded TDBU & Day & Night: when lowering the shade, lower the bottom rail first and then middle rail. When raising the shade, raise the middle rail first and then bottom rail.

For Corded: operate as below illustration, according to the location of cord lock.

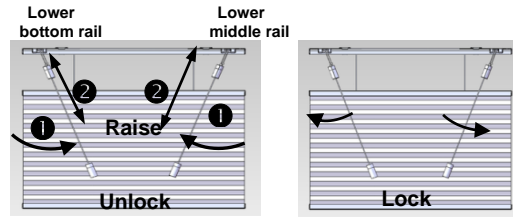

Remove the Shade

- For Corded / Corded Day & Night, fully raise the shade
- For Corded TDBU, lower the mid rail
- Insert screwdriver into the gap between the back of the rail and the bracket. Gently maneuver the screwdriver toward yourself to pry the bracket.

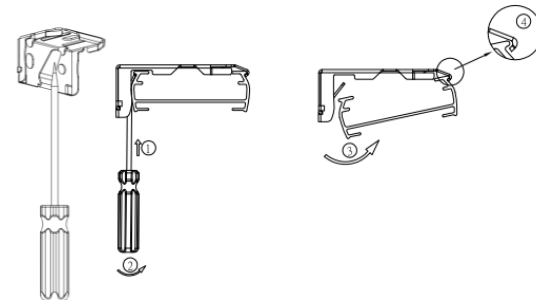

How to Reassemble Ellipse Safety Cord Connector (In case this is selected)

Step 1



Step 2



Step 3



Step 1: Place all the cords into the slot of Ellipse Safety Cord Connector in order

Step 2: Close the Ellipse Safety Cord Connector

Step 3: Pull the tassel cords and make sure it is closed tightly

Safety Warning

Warning! Children can strangle if this safety device is not installed. Always use this device to keep cords out of the reach of children. This device should be installed as close to the headrail as possible and, in all cases, NOT LESS THAN 1.6m from the floor.

Please make sure the cord/chain is secured as shown, and always wrap all loose cords around the cord cleats in a figure of 8 pattern as shown, after each operation of the blind. Inspect the cleats at regular intervals to ensure they are still firmly fixed.

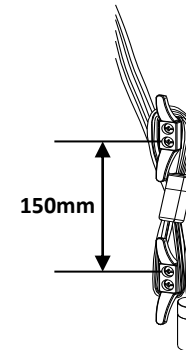

Cleaning

Routine cleaning will help maintain the beauty of your shade. The shade can be cleaned by using a soft brush, vacuumed with a low suction hand-held vacuum, cleaned ultrasonically (specify that a mild solution must be used and that the head rail should never be immersed in liquid), or dampen a clean cloth with a warm water and mild detergent solution to dab the spot until it's gone (do not rub!).

Warning Label

A warning label is permanently attached to the cord. Do not remove this safety label, even after installation

WARNING
ALL WINDOW COVERINGS WITH CORD OR CHAIN

To avoid creating a possible strangulation hazard for children, the corded or chained internal window covering must be installed in such a way that a loose cord or chain cannot form a loop 220mm or longer at a height of less than 1600mm above floor level.

- A cord/chain guide may be installed lower than 1600mm above floor level if the cord/chain is sufficiently secured or tensioned to prevent a loop 220mm or longer from being formed.
- If a cord/chain guide is installed lower than 1600mm above floor level, it must be designed to prevent a child from being able to remove the cord/chain.
- If a cleat is used to secure the cord, it must be at least 1600mm above floor level because a child is capable of unwinding a cord from a cleat.